

Seamless Series
Seamless Table Manual

SL402-EN-V01



GREEN
FURNITURE
CONCEPT



Index

Modules	p3
Components Seamless Table	p4
Recycling of parts	p5
Parts Seamless Table	p6
Assembly instructions Seamless Table	p7-8
Parts Chargers for Seamless Table	p9
Assembly instructions Chargers for Seamless Table	p10-11



Products - Seamless Table

Seamless Series

Seamless Table 240

The Seamless Table 240 is a 2400mm straight module comprising a table top and a trunk. It is also available with a round cutout for connection to the Leaf Lamp Link Tree with Table.



Seamless Table 30°

The Seamless Table 30° has a 30 degree curvature to be placed in any Seamless Table configuration. module comprising a table top and a trunk. It is also available with a round cutout for connection to the Leaf Lamp Link Tree with Table.



Seamless Table Endpiece

The Seamless Table Endpiece is a half-circle module comprising a table top and a trunk. It is also available with a round cutout for connection to the Leaf Lamp Link Tree with Table.



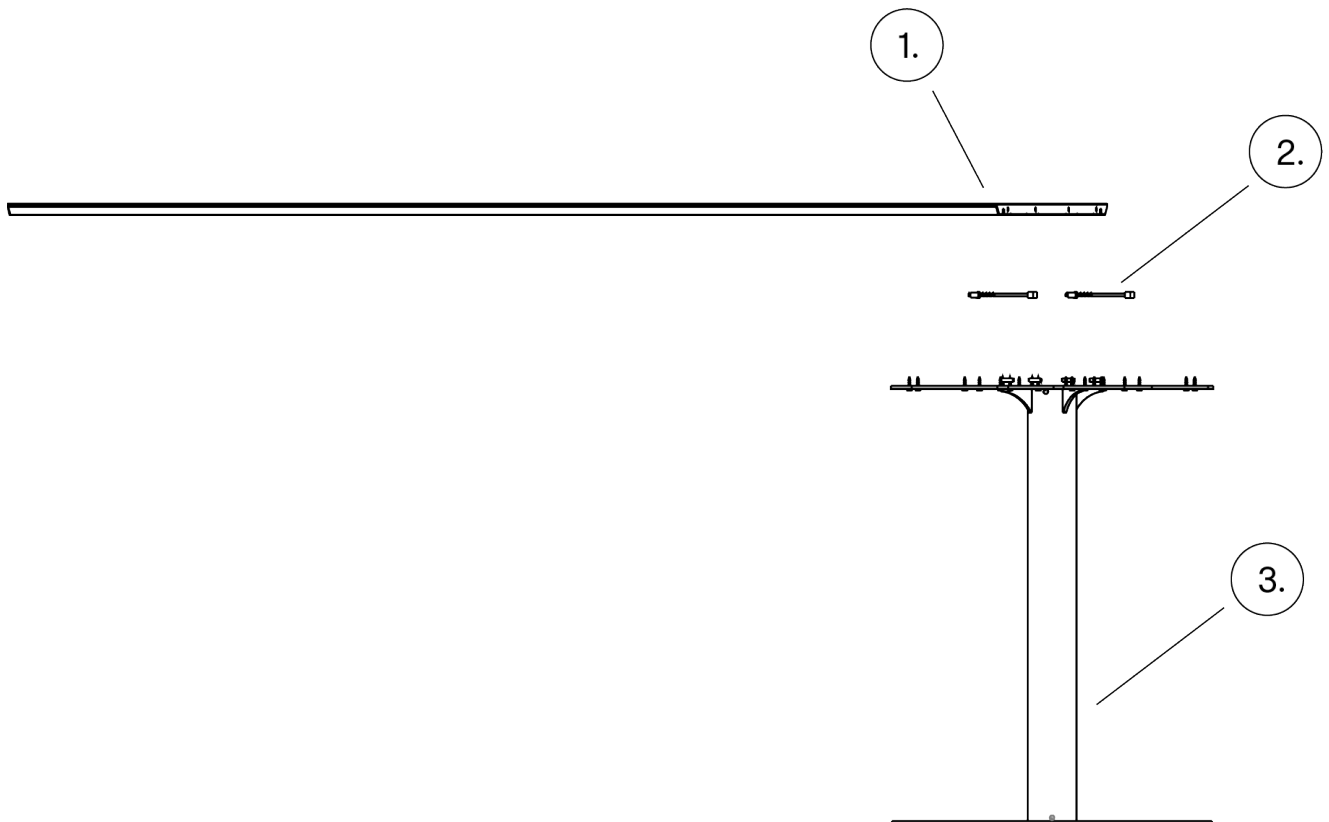

Numbers components

1. Seamless Table Top
2. Connecting armature
3. Seamless Table Lower Trunk

Recycling – Parts

Seamless Table

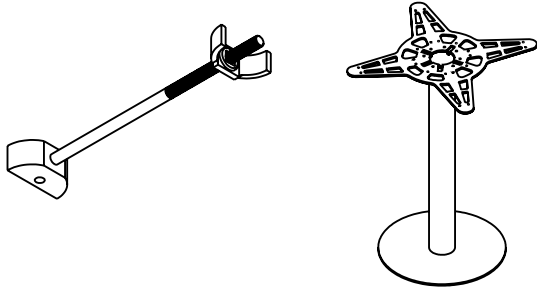

Steel parts

All metal parts such as the trunk should be recycled as steel.

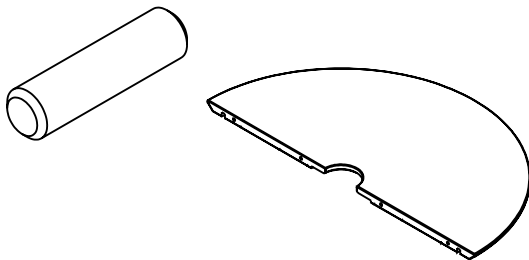

Wood parts

Wooden parts such as table tops and dowels should be separated and recycled as wood.

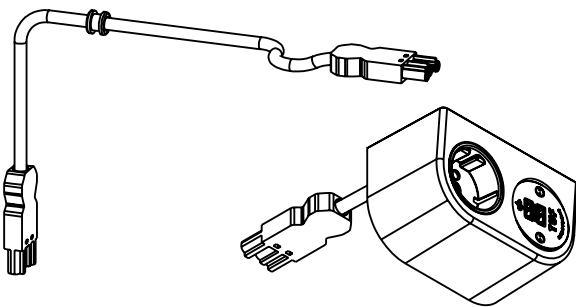

Electrical components

All electrical components such as cables, chargers and sockets should be separated and recycled as electronic waste.



Parts – Seamless Table

Seamless Table 240, 30° & Endpeice

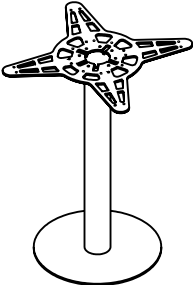
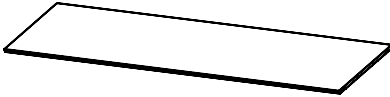
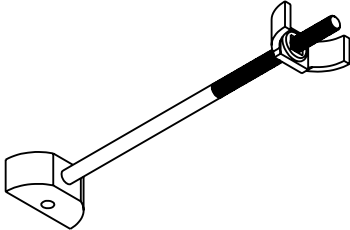
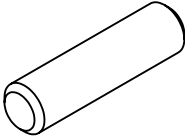
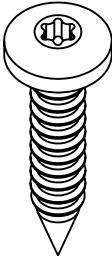
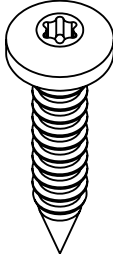
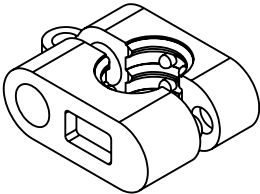
 <p>Seamless Table Lower Trunk BA00065 x1</p>	 <p>Seamless Table Wood Top (Depending on product) x1</p>	 <p>Connecting Armature CC150 SP076 x2</p>
 <p>Wood Dowel 8x30 SP140 x4</p>	 <p>Roundhead Wooden Screw Torx 5x30 SP071 x20</p>	 <p>Roundhead wooden screw 5x35 SP146 x4</p>
 <p>Cord Relief Clamp SP143 x4</p>		

Assembly Instructions – Seamless Table

Seamless Table 240, 30° & Endpeice

1

NOTE: All assembly steps are the same regardless of which module of the Seamless Table is being assembled. Example shows assembly of Seamless Table 240.

Place the table top on the seamless table lower trunk. Make sure to align the holes of the star disk with the slots in the table top.

2

Roundhead Wooden Screw Torx 5x30

Use the 5x30 wooden screw to attach the table top to the seamless table lower trunk.

3

Seamless table modules can be connected to any other seamless table module or Leaf Lamp Link Tree M & L w Table.

4

Place the wood dowels in the holes in the table top.

5

Place the connecting armatures in the assigned slots.

6

Use an allen key to tighten two table tops together. Repeat on both sides.
NOTE: Allen key not included.

Assembly Instructions – Seamless Table to Leaf Lamp Link Tree w Table

1

NOTE: All assembly steps are the same regardless of which module of the Seamless Table is being assembled. Example shows assembly of Seamless Table 240.

Seamless Table modules can be connected to Leaf Lamp Link Tree M & L w Table. All table tops connected to a tree needs a cut out on either side.

2

Place the seamless table module against the trunk of the tree.

3

Roundhead Wooden Screw Torx 5x30

Attach the table top from the seamless table module using the 5x30 wooden screw in the points of the star disk and in all holes of the inner circle.

4

Place the connecting armature in the assigned slots under the table tops. Repeat with the second connecting armature on the other side.

5

To tighten the connection armatures and close the gap between the table tops, use an allen key. **NOTE:** Allen key not included.



6

Finished assembly of Seamless Table to Leaf Lamp Link Tree w Table.

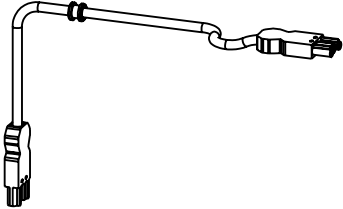
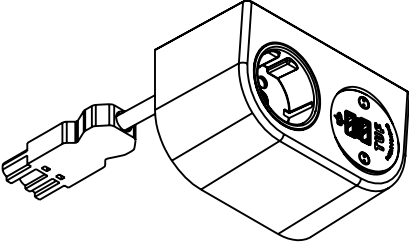
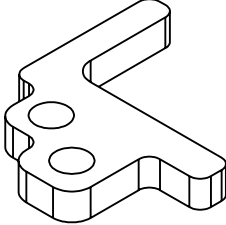
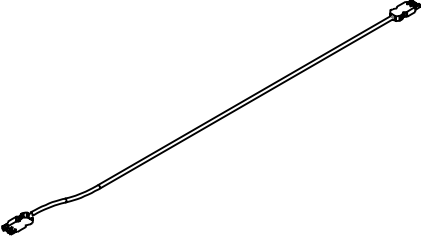
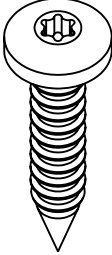
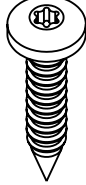

Parts – Chargers for Seamless Table

Seamless Table 240, 30 ° & Endpiece

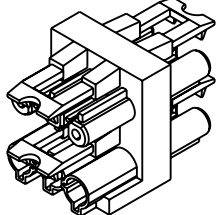
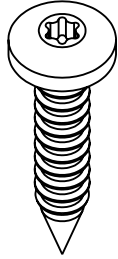
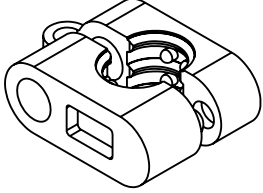
 <p>Interconnecting cable 500 mm EC083 x4</p>	 <p>Phase Charger 120 mm EC082 x2</p>	 <p>Bracket for Phase BP00093 x4</p>
 <p>Interconnecting cable 1900 mm EC087 x1</p>	 <p>Roundhead wooden screw 5x25 SP002 x4</p>	 <p>Roundhead Wooden Screw Torx 5x16 SP116 x11</p>
 <p>Cable Clip SP108 x11</p>	 <p>Adaptor Block GST 1-3 EC001 x1</p>	 <p>Roundhead wooden screw 5x35 SP146 x4</p>
 <p>Cord Relief Clamp SP143 x4</p>		

Assembly Instructions – Chargers for Seamless Table



Seamless Table 240, 30 ° & Endpiece

1

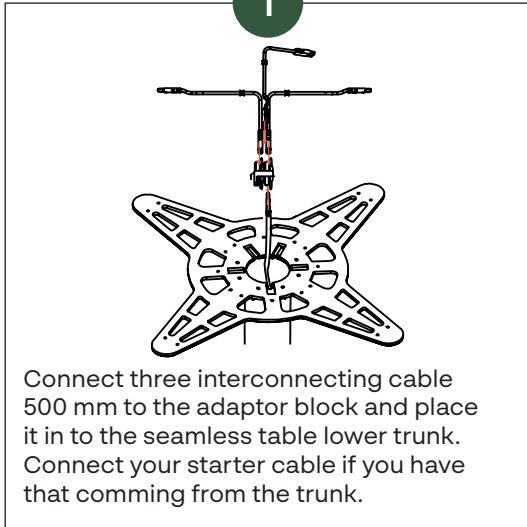

Connect three interconnecting cable 500 mm to the adaptor block and place it in to the seamless table lower trunk. Connect your starter cable if you have that coming from the trunk.

2

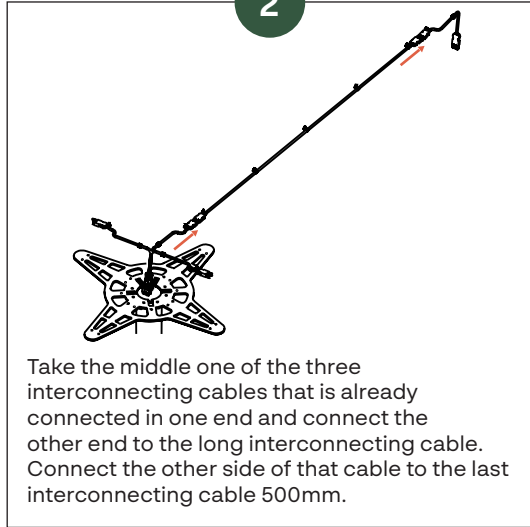

Take the middle one of the three interconnecting cables that is already connected in one end and connect the other end to the long interconnecting cable. Connect the other side of that cable to the last interconnecting cable 500mm.

3

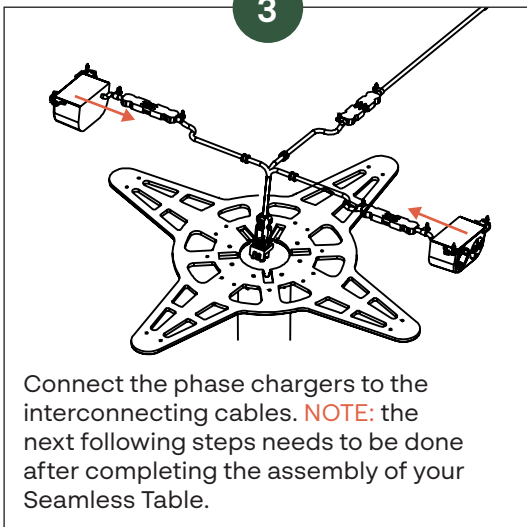

Connect the phase chargers to the interconnecting cables. **NOTE:** the next following steps needs to be done after completing the assembly of your Seamless Table.

4

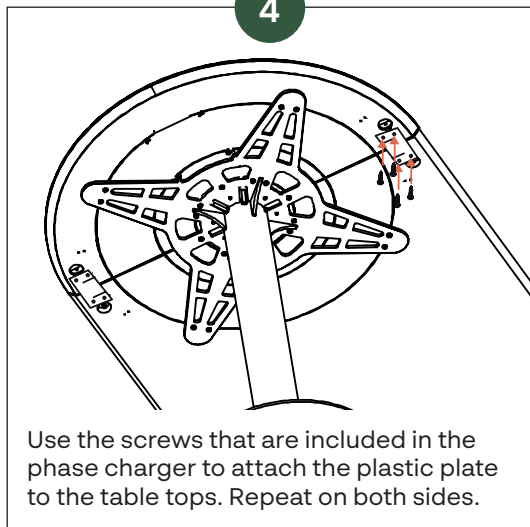

Use the screws that are included in the phase charger to attach the plastic plate to the table tops. Repeat on both sides.

5

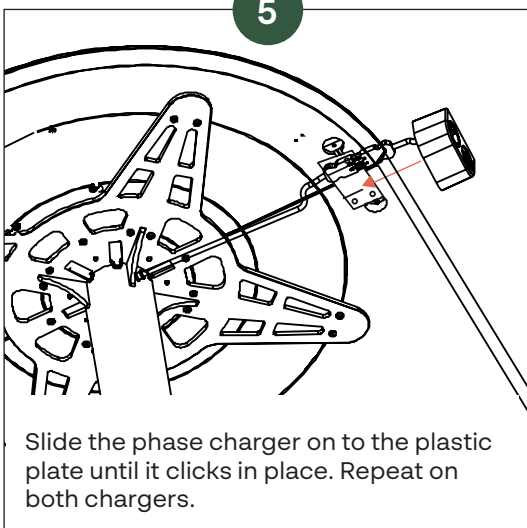

Slide the phase charger on to the plastic plate until it clicks in place. Repeat on both chargers.

6

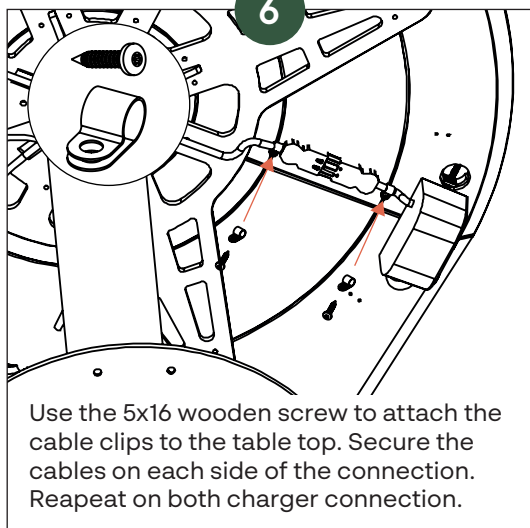

Use the 5x16 wooden screw to attach the cable clips to the table top. Secure the cables on each side of the connection. Repeat on both charger connection.

Assembly Instructions – Chargers for Seamless Table



Seamless Table 240, 30 ° & Endpiece

