

ARCONAS

Connex Configurations

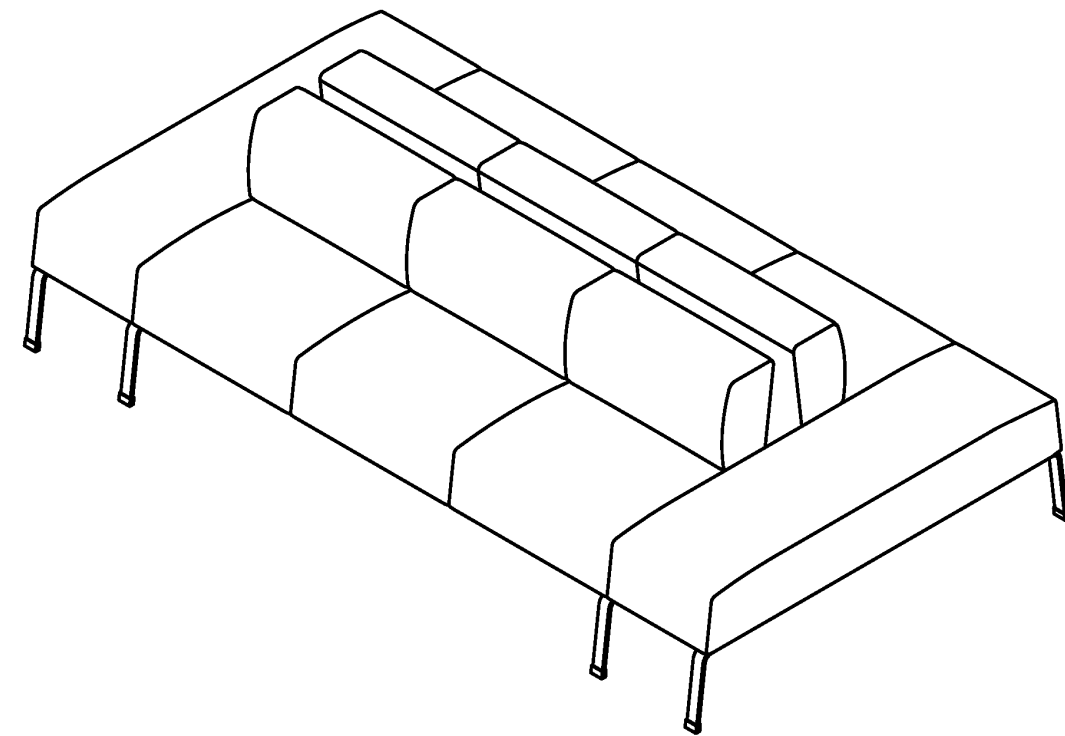
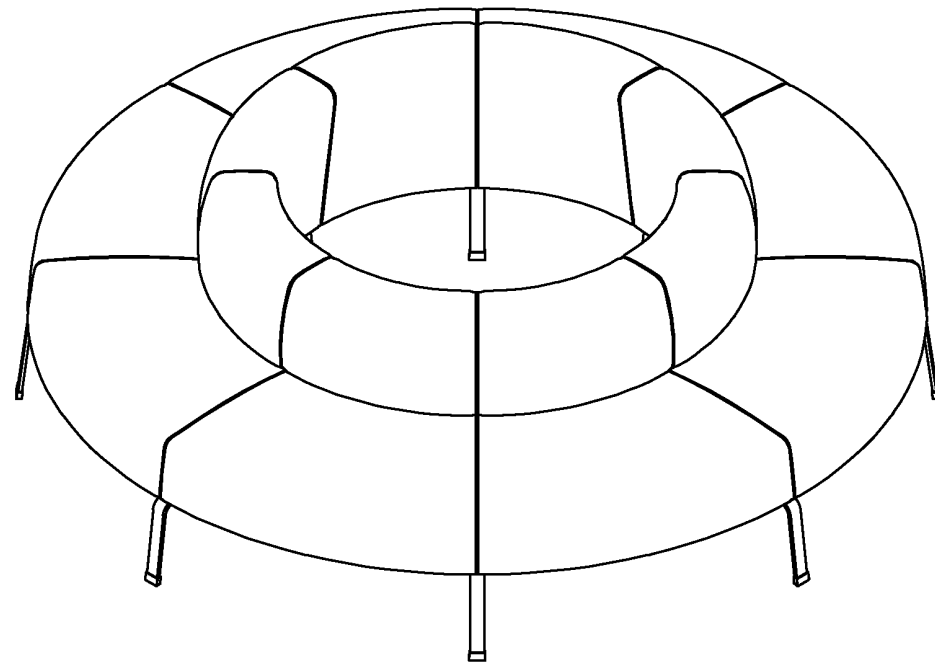

Connex

CON10F

flush full back chair

Plan View

24.5"W x 26.4"D x 29.5"H | 625mm W x 670mm D x 750mm H



Front View



Side View



Isometric View



Seat Height - 18.5"/469mm
Floor Clearance - 9.9"/250mm

CON20F

two seat flush full back sofa

Plan View

49"W x 26.4"D x 29.6"H | 1248mm W x 670mm D x 753mm H

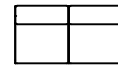

Front View

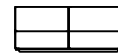

Side View



Isometric View

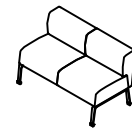

CON29FL/R

two seat flush back sofa, flush end on right or left when seated

Plan View

49"W x 26.4"D x 29.6"H | 1248mm W x 670mm D x 753mm H

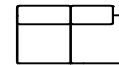

Front View

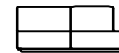

Side View



Isometric View

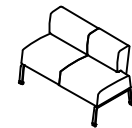

CON30F

three seat flush full back sofa

Plan View

73.5"W x 26.4"D x 29.6"H | 1870mm W x 670mm D x 753mm H

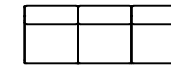

Front View

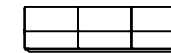

Side View



Isometric View

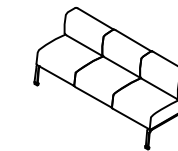

Connex Benches

CON01B
ottoman

Plan View
24.5"W x 22"D x 18.5"H | 625mm W x 561mm D x 469mm H



Front View



Side View



Isometric View



Seat Height - 18.5"/469mm
Floor Clearance - 9.9"/250mm

CON02B
two seat bench

Plan View
49"W x 22"D x 18.5"H | 1248mm W x 561mm D x 469mm H



Front View

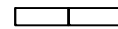

Side View



Isometric View

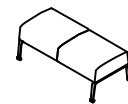

CON03B
three seat bench

Plan View
73.5"W x 22"D x 18.5"H | 1870mm W x 561mm D x 469mm H

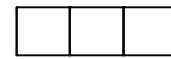

Front View

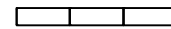

Side View



Isometric View

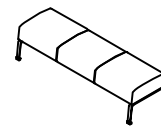

CON15SB
single 15" side bench

Plan View
15.5"W x 22"D x 18.5"H | 397mm W x 561mm D x 469mm H



Front View



Side View



Isometric View



CON15SBBTOB
double 15" side bench (for back to back units)

Plan View
15.5"W x 55.5"D x 18.5"H | 397mm W x 1409mm D x 469mm H



Front View



Side View

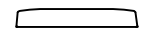

Isometric View

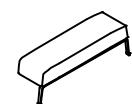

Connex Curved Units

CON1301C
30 degree inside wedge

Plan View
40"W x 26.4"D x 29.5"H | 1027mm W x 670mm D x 750mm H

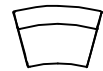

Front View

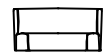

Side View



Isometric View

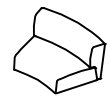

Seat Height - 18.5"/469mm
Floor Clearance - 9.9"/250mm

CON1300C
30 degree outside wedge

Plan View
38"W x 26.4"D x 29.5"H | 972mm W x 670mm D x 750mm H



Front View



Side View



Isometric View



CON1451C
45 degree inside wedge

Plan View
40"W x 26.4"D x 29.5"H | 1010mm W x 670mm D x 750mm H



Front View



Side View



Isometric View



CON1450C
45 degree outside wedge

Plan View
36.5"W x 26.4"D x 29.5"H | 928mm W x 670mm D x 750mm H



Front View



Side View



Isometric View



CON130B
30 degree bench

Plan View
38"W x 22"D x 29.5"H | 972mm W x 560mm D x 750mm H



Isometric View



CON145B
45 degree bench

Plan View
36.5"W x 22"D x 29.5"H | 928mm W x 560mm D x 750mm H



Isometric View



ARCONAS

Connex Arm/Armless Chairs and Sofas

CON10AL/R
armchair, arm on left or right when seated

Plan View
34.5"W x 27.7"D x 29.5"H | 879mm W x 703mm D x 750mm H



Isometric View



CON10FAL/R
armchair with full back, arm on left or right when seated

Plan View
34.5"W x 27.7"D x 29.5"H | 879mm W x 703mm D x 750mm H



Isometric View

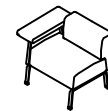

CON20A
two seat sofa with arms

Plan View
69"W x 27.7"D x 29.6"H | 1756mm W x 703mm D x 753mm H

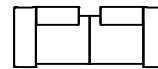

Isometric View

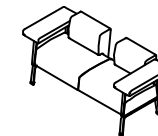

CON20FA
two seat sofa, full back with arms

Plan View
69"W x 27.7"D x 29.6"H | 1756mm W x 703mm D x 753mm H

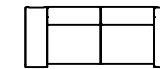

Isometric View

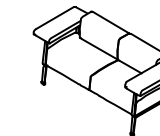

CON30A
three seat sofa with arms

Plan View
83.5"W x 27.7"D x 29.6"H | 879mm W x 703mm D x 753mm H

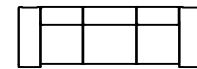

Isometric View

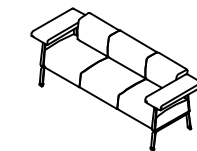

CON29FAL/R
two seat flush back sofa, arm on left or right when seated

Plan View
54"W x 27.7"D x 29.6"H | 1375mm W x 703mm D x 753mm H

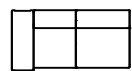

Isometric View

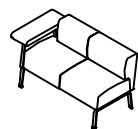

CON22TA
twist sofa

Plan View
69"W x 27.7"D x 29.6"H | 1756mm W x 703mm D x 753mm H

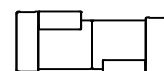

Isometric View

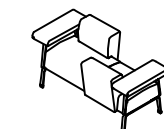

CON10N
chair

Plan View
29.5"W x 26.4"D x 29.5"H | 752mm W x 670mm D x 750mm H



Isometric View



CON20N
two seat sofa

Plan View
59"W x 26.4"D x 29.6"H | 1502mm W x 670mm D x 753mm H

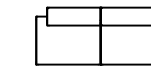

Isometric View

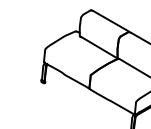

CON30N
three seat sofa

Plan View
73.5"W x 26.4"D x 29.6"H | 1870mm W x 670mm D x 753mm H

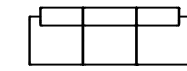

Isometric View

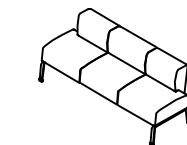

Seat Height - 18.5"/469mm
Floor Clearance - 9.9"/250mm

Connex Legs

CONCLEG
connecting center leg

Plan View
24.5"D x 9.9"H | 626mm D x 250mm H



Isometric View



CONLEG
end leg

Plan View
24.5"D x 9.9"H | 625mm D x 250mm H



Isometric View



CONLEGSB
end leg for side bench (back to back unit)

Plan View
55.5"D x 9.9"H | 1409mm D x 250mm H



Isometric View



Connex Tables

CON12N
12" inline connecting table

Plan View
12"W x 21"D x 10.6"H | 305mm W x 533mm D x 269mm H



Isometric View



CON24N
24" inline connecting table

Plan View
24"W x 21"D x 10.6"H | 610mm W x 533mm D x 269mm H



Isometric View



CON90C
90 degree connecting table

Plan View
21.9"W x 21.9"D x 10.6"H | 557mm W x 557mm D x 269mm H



Isometric View



CON12E
12" end table

Plan View
12"W x 21"D x 10.6"H | 305mm W x 533mm D x 269mm H



Isometric View



CON24E
24" end table

Plan View
24"W x 21"D x 10.6"H | 610mm W x 533mm D x 269mm H



Isometric View

