

# ARCONAS

## Flyaway Configurations

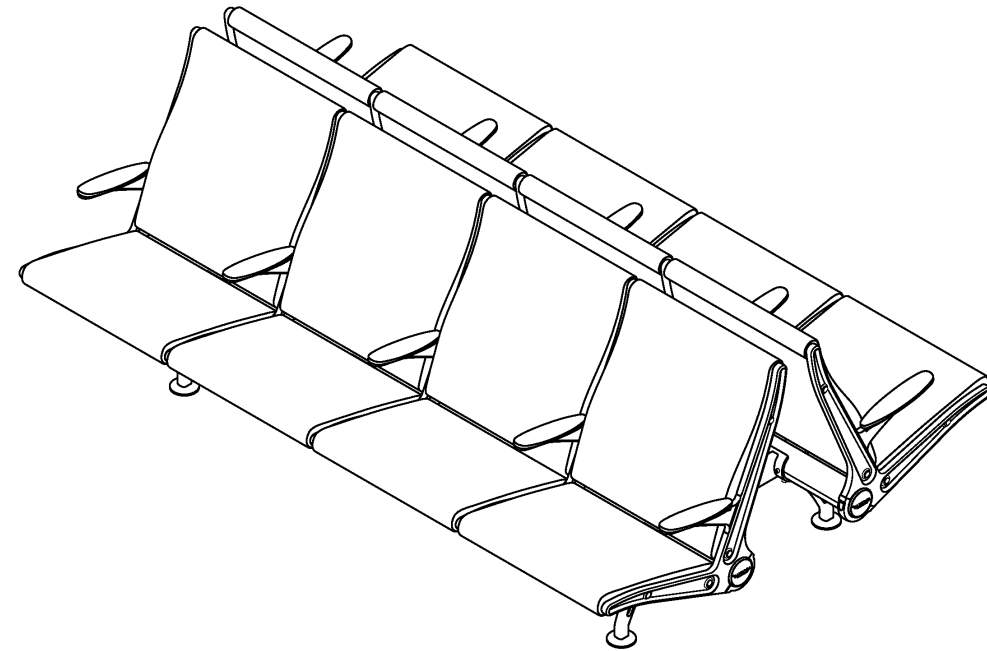
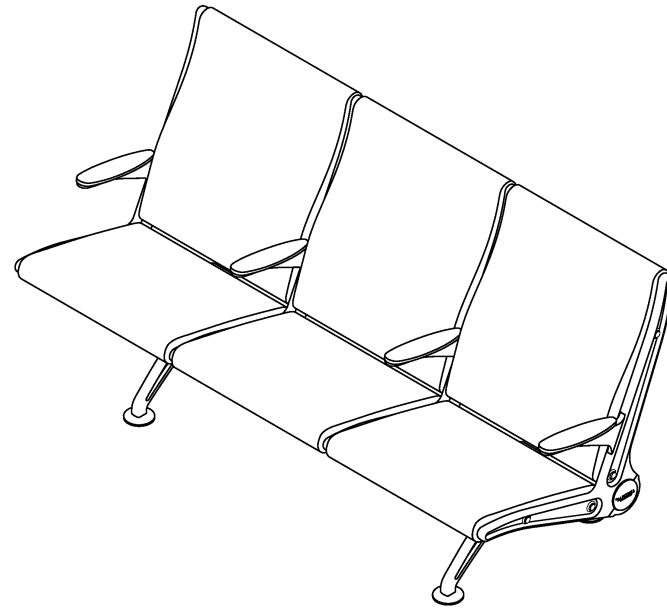
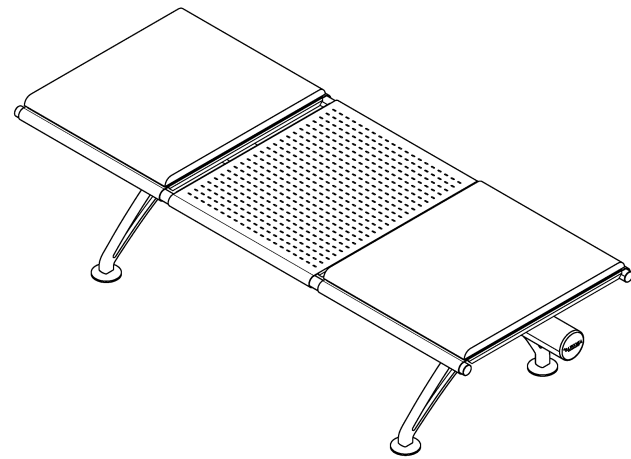

# ARCONAS

## Flyaway

2 Seater  
FLY2S

Plan View - 48.2"L x 29.6"D x 36.5"H  
1224 mm x 751 mm x 927 mm



Front View - 48.2"L x 29.6"D x 36.5"H  
1224 mm x 751 mm x 927 mm

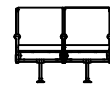

Side View - 48.2"L x 29.6"D x 36.5"H  
1224 mm x 751 mm x 927 mm



Isometric View - 48.2"L x 29.6"D x 36.5"H  
1224 mm x 751 mm x 927 mm



3 Seater  
FLY3S

Plan View - 71"L x 29.6"D x 36.5"H  
1803 mm x 751 mm x 927 mm

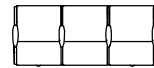

Front View - 71"L x 29.6"D x 36.5"H  
1803 mm x 751 mm x 927 mm

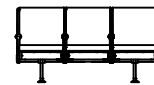

Side View - 71"L x 29.6"D x 36.5"H  
1803 mm x 751 mm x 927 mm



Isometric View - 71"L x 29.6"D x 36.5"H  
1803 mm x 751 mm x 927 mm



4 Seater  
FLY4S

Plan View - 97.3"L x 29.6"D x 36.5"H  
2379 mm x 751 mm x 927 mm

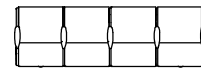

Front View - 97.3"L x 29.6"D x 36.5"H  
2379 mm x 751 mm x 927 mm

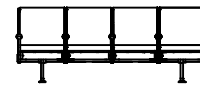

Side View - 97.3"L x 29.6"D x 36.5"H  
2379 mm x 751 mm x 927 mm



Isometric View - 97.3"L x 29.6"D x 36.5"H  
2379 mm x 751 mm x 927 mm

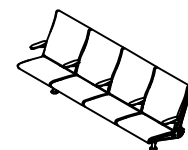

5 Seater  
FLY5S

Plan View - 116.5"L x 29.6"D x 36.5"H  
2959 mm x 751 mm x 927 mm

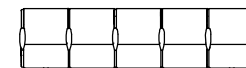

Front View - 116.5"L x 29.6"D x 36.5"H  
2959 mm x 751 mm x 927 mm



Side View - 116.5"L x 29.6"D x 36.5"H  
2959 mm x 751 mm x 927 mm



Isometric View - 116.5"L x 29.6"D x 36.5"H  
2959 mm x 751 mm x 927 mm

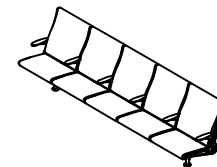

18.75" seat height

# ARCONAS

## Flyaway

2 Seater  
FLY4D

Plan View - 48.2"L x 29.6"D x 36.5"H  
1224 mm x 1562 mm x 927 mm

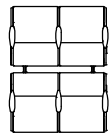

Front View - 48.2"L x 29.6"D x 36.5"H  
1224 mm x 1562 mm x 927 mm

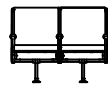

Side View - 48.2"L x 29.6"D x 36.5"H  
1224 mm x 1562 mm x 927 mm



Isometric View - 48.2"L x 29.6"D x 36.5"H  
1224 mm x 1562 mm x 927 mm



3 Seater  
FLY6D

Plan View - 71"L x 61.5"D x 36.5"H  
1803 mm x 1562 mm x 927 mm

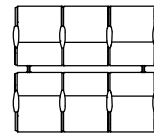

Front View - 71"L x 61.5"D x 36.5"H  
1803 mm x 1562 mm x 927 mm

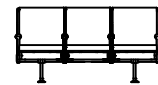

Side View - 71"L x 61.5"D x 36.5"H  
1803 mm x 1562 mm x 927 mm



Isometric View - 71"L x 61.5"D x 36.5"H  
1803 mm x 1562 mm x 927 mm

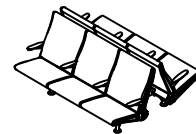

4 Seater  
FLY8D

Plan View - 97.3"L x 61.5"D x 36.5"H  
2379 mm x 1562 mm x 927 mm

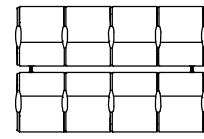

Front View - 97.3"L x 61.5"D x 36.5"H  
2379 mm x 1562 mm x 927 mm

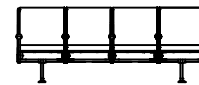

Side View - 97.3"L x 61.5"D x 36.5"H  
2379 mm x 1562 mm x 927 mm



Isometric View - 97.3"L x 61.5"D x 36.5"H  
2379 mm x 1562 mm x 927 mm

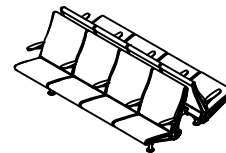

5 Seater  
FLY10D

5 Seater - 116.5"L x 61.5"D x 36.5"H  
2959 mm x 1562 mm x 927 mm

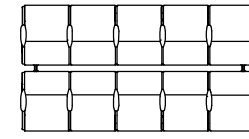

5 Seater - 116.5"L x 61.5"D x 36.5"H  
2959 mm x 1562 mm x 927 mm



5 Seater - 116.5"L x 61.5"D x 36.5"H  
2959 mm x 1562 mm x 927 mm



5 Seater - 116.5"L x 61.5"D x 36.5"H  
2959 mm x 1562 mm x 927 mm

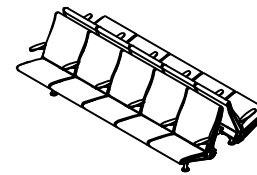

18.75" seat height

# ARCONAS

## Flyaway

2 Seater  
FLY2B

Plan View - 45"L x 26"D x 18"H  
1143 mm x 660 mm x 457 mm

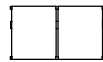

Isometric View - 45"L x 26"D x 18"H  
1143 mm x 660 mm x 457 mm



3 Seater  
FLY3B

Plan View - 68"L x 26"D x 18"H  
1727 mm x 660 mm x 457 mm

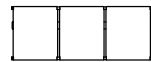

Isometric View - 68"L x 26"D x 18"H  
1727 mm x 660 mm x 457 mm

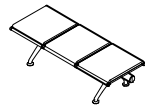

4 Seater  
FLY4B

Plan View - 91"L x 26"D x 18"H  
2311 mm x 660 mm x 457 mm

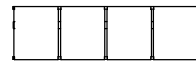

Isometric View - 91"L x 26"D x 18"H  
2311 mm x 660 mm x 457 mm

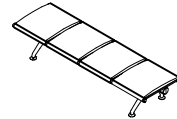

5 Seater  
FLY5B

Plan View - 114"L x 26"D x 18"H  
2896 mm x 660 mm x 457 mm

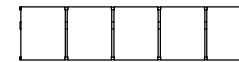

Isometric View - 114"L x 26"D x 18"H  
2896 mm x 660 mm x 457 mm

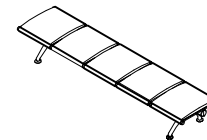

# ARCONAS

## Flyaway

Cluster  
FLYCLUSTER

Plan View - 106"L x 92"D x 36.5"H  
2692 mm x 2336 mm x 927 mm

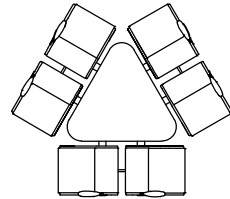

Isometric View - 106"L x 92"D x 36.5"H  
2692 mm x 2336 mm x 927 mm

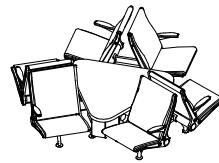

# ARCONAS

## Flyaway

3 Seat Unit with End Table  
\*End Table Available on All Line Units  
79"Lx29.6"Dx36.5"H - 2006mmx751mmx927mm

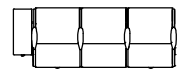

3 Seater with Int. Table  
71.0"L x 29.6"D x 36.5"H - 1803mm x 751mm x 927mm

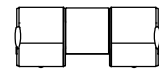

4 Seater with Int. Table  
93.7"Lx29.6"Dx36.5"H - 2379mmx751mmx927mm

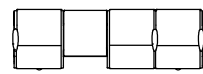

5 Seater with Int. Table  
116.5"Lx29.6"Dx36.5"H-2959mmx751mmx927mm

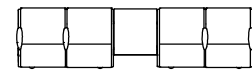

3 Seat Units with Corner Table  
\*Corner Table Available on All Corner Units

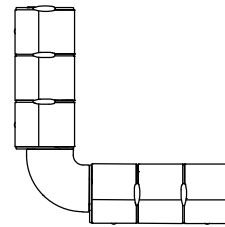

# ARCONAS

## Flyaway

2 Seat Unit with Footrest and Intermediate Table

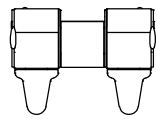

4 Seat Unit Back to Back with Footrest and Intermediate Tables

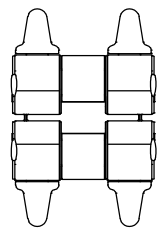

19" seat height

3 Seat Unit with Footrest and Intermediate Tables

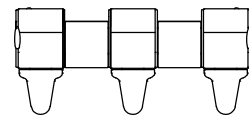

6 Seat Unit Back to Back with Footrest and Intermediate Tables

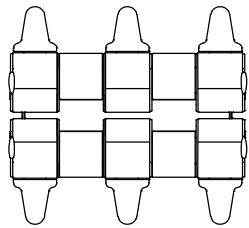

Linear Units with Footrests



Isometric View with Footrests

